

# LUXMAN 820

MW/LW/FM STEREO RECEIVER model R820 OPERATION MANUAL

You are about to begin a new high fidelity experience. The LUXMAN R-820 Receiver is unique in the annals of high fidelity equipment. Though built with extremely sophisticated engineering, its concept is exceedingly simple: to produce a receiver with performance comparable to that available in the finest separate tuners, preamplifiers and amplifiers.

After extensive research, the R-820 was designed without compromise to provide high output, low distortion and an exceptionally wide range of available power. In addition, this unit reflects great attention to control flexibility and human engineering.

The R-820 represents the finest standards of design and craftsmanship, but the proof is in the handling . . . and in the hearing. As you proceed to connect the receiver, may we suggest you read all the instructions carefully before turning the unit on? A few moments invested now can eliminate doubts or delays later.

If you have any questions, please do not hesitate to consult your dealer, or distributor in your territory.

Pleasurable listening!

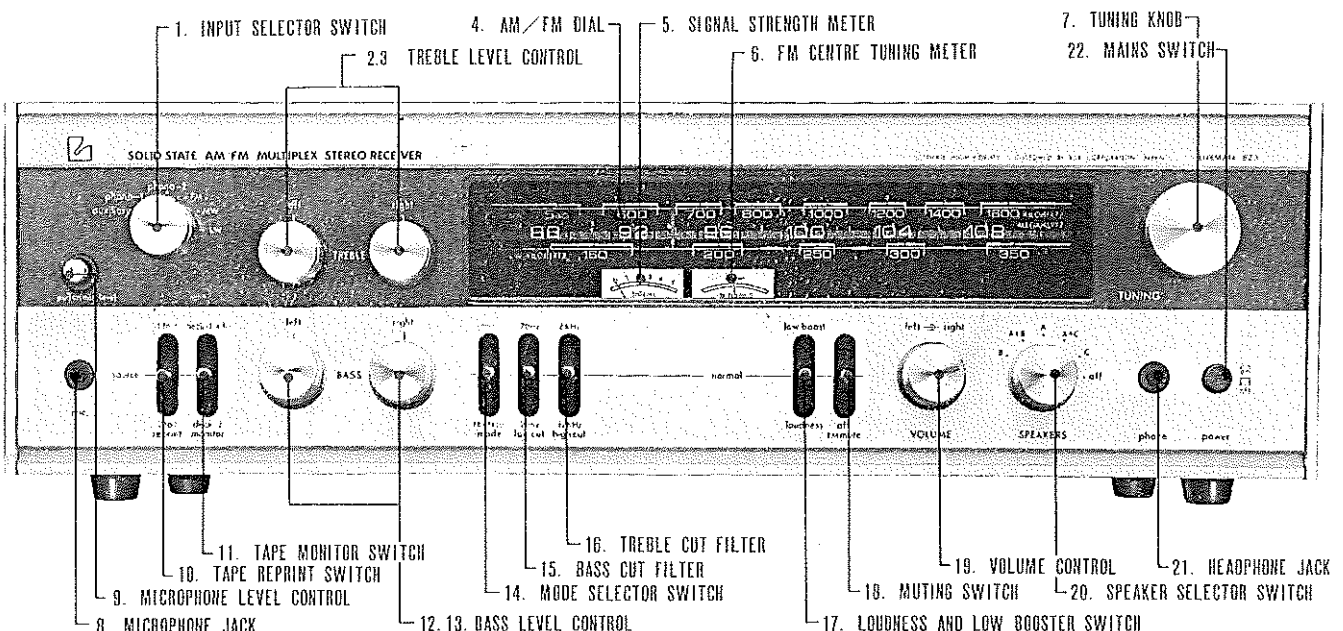

## NAME AND USAGE OF EACH CONTROL

### 1. Input Selector Switch

This switch permits proper selection of desired programme sources. You may set either of the positions (Aux, Phono-1, Phono-2, FM, MW, LW).

### 2. 3. Treble Level Control(TREBLE)

A clockwise turn of this knob boosts the treble response, and counterclockwise decreases the treble. This knob has the click-stopper of 11 points, and yields flat frequency response at the centre of rotation angle. The left knob(2) is effective on the left channel and the right one(3) for the right, which allows independent control of both channels.

### 4. LW/MW/FM Dial

Turn the tuning knob according to the frequencies marked on this dial and the desired signal can be received. Receivable frequency range for FM is from 88MHz to 108MHz, while for MW from 525KHz to 1605KHz and LW from 145KHz to 350KHz. When a stereo FM is being received the "stereo" beacon is illuminated.

### 5. Signal Strength Meter

The accurate tuning point can be obtained when the needle of this meter shows its maximum swing. The movement of the needle depends on the strength of the receiving signal. Even if the needle swings to the extreme right it does not impair the meter. But for perfect reproduction of stereo FM, it is recommended to have the needle's swing exceeding "4" on this meter.

In case of FM reception such signals as cannot be cut off when the muting switch(18) is at the "normal" position are used as stereo reception.

### 6. FM Centre Tuning Meter

When no FM signal is received this pointer rests in the vicinity of the centre position. When the tuning knob(7) is turned and the needle of signal strength meter(5) begins to swing, the needle of this meter comes out of the centre, and as the accurate tuning point is getting very near the needle comes back again closer to the centre. Thus the accurate tuning point can be obtained with the needle at the dead centre position. This meter is exclusively effective on FM, and in case of MW/LW reception the needle does not move from its centre point.

### 7. Tuning Knob(TUNING)

Use this knob for tuning on station. When any desired signal is received, make accurate tuning, slowly so that the pointer of signal strength meter(5) shows its maximum swing and that for centre tuning meter(6) comes to its centre position. For MW/LW reception this centre tuning meter does not operate.

### 8. Microphone Jack(mic.)

Input sensitivity 2mV; input impedance 60K $\Omega$

Sound mixing of mic input with other programme sources is possible when a microphone is plugged in. This standardized jack accepts a mono microphone of 600 $\Omega$  (low impedance) or 50K $\Omega$  (high impedance) type and the input is amplified and controlled by the level control volume(9) so that it can be mixed to both channels. This receiver can be used as a public address amplifier as well. In this case, it is recommended to set the selector switch(1) at an open position of AUX as otherwise there is a possible noise problem. It is also desirable to set low cut filter and adjust tone controls to reduce the amount of low frequencies though this depends on the speakers you use.

### 9. Microphone Level Control(pull on mic. level)

The input level of the microphone jack(8) is controlled by this knob. Normally this switch should be left pressed in. Pull the knob out-wards and the circuit is put into operation. Then turn it clockwise so that an appropriate level can be obtained. A word of warning: do not turn the main amplifier volume up too loud as annoying feedback "howl" might take place between your speakers and microphone. Experimenting will help you find the best levels for each of these controls.

### 10. Tape Reprint Switch

The reprint lever switch has three positions: in the centre position "source", which is the programme source as selected by the function selector. When moved to the "up" position(1 to 2) it will allow the output of tape recorder "1" to go to the input of tape recorder "2" for dubbing (reprint). From tape recorder "2" to tape recorder "1" is allowed.

### 11. Tape Monitor Switch

When this switch is lifted up to the "deck-1(4 CH)" position playback from "TAPE IN 1" is possible, while at the "2" position "TAPE IN 2" is reproduced. The tape connector (31) is also functionable when the switch is set

at the "2" position, i.e. it functions in parallel with "TAPE IN 2". In case of 3-head tape-recorder which has playback head for playback in the course of recording simultaneous playback monitoring is then possible while recording. In this case this receiver receives the playback signals from either of TAPE IN 1, TAPE IN 2, or tape connector while feeding the recording signals to TAPE OUT 1, TAPE OUT 2 and tape connector. Remember that this switch must be set at the corresponding position to which the tape recorder is connected. Caution: If this switch is at the "source" position no playback is possible from tape recorder.

#### **12. 13. Bass Level Control(BASS)**

A clockwise turn boosts the bass response, while counterclockwise decreases or cuts the bass. Functionwise, these are same as the treble level controls(2,3).

#### **14. Mode Selector Switch**

This switch allows selection of sound reproduction modes such as Stereophonic and Monaural. For further details refer to the "Mode Selection".

#### **15. Bass Cut Filter**

With this switch low frequency range can be cut off at the rate of 6dB/oct. Reduction at this rate can be made either below 70Hz or 20Hz. See the further details in the "Operation of Low Cut Filter".

#### **16. Treble Cut Filter**

Setting of this switch reduces the amount of high frequencies either above 6KHz or 12KHz at the rate of 6dB/oct. See the further details in the "Operation of Treble Cut Filter".

#### **17. Loudness and Low Booster Switch**

This switch has 3 positions offering flat frequency response and loudness control as well as low booster. Refer to the "Operation of Loudness and Low Booster Switch".

#### **18. Muting Switch(MUTING)**

Interstation noise which is possible when the tuning point is drifted can be eliminated by this switch in FM reception. Use this to cut off muting noise or other impractically weak radio signals. Broadcasts which can be received at the muting-on position are practical for stereo reception. It is recommended to keep this switch always "normal" except when a weak signals is received.

#### **19. Volume Control(VOLUME)**

This knob controls volume. Clockwise turn boosts volume, while counterclockwise decreases until it is inaudible. This knob is a dual friction type and plays a role of balancer as well offering separate control of right and left channels. The outer one is for the right channel, while the inner for left. Usually this knob controls volume of both channels simultaneously. To control either of both channels you may turn the control for your desired channel, at the same time holding fixing the other by hand. When the volume on both channels is balanced monaural reproduction sound comes from the centre of both right and left channels. Normally this receiver is delivered from the factory well balanced in volume showing a straight concave line on the knob. In view of the most frequent use of this control the knob is contoured by light-blue color on the front panel for easy identification.

#### **20. Speaker Selector Switch(SPEAKERS)**

This receiver offers convenient use of 3 pairs of speaker systems. You can choose independent or simultaneous driving of 1 or 2 systems among 3 pairs as per the indication on the panel. When the knob is set at the "B" position B speaker terminals(28) start to function, and likewise at the "A + B" position both A and B speaker terminals(27, 28) simultaneously operate.

#### **21. Headphone Jack(phone)**

Connection of stereophonic headphone to this jack allows private listening. Output signals are always available irrespective of the position of speaker selector switch(19). For use of stereophonic headphone, however, it is recommended to set the speaker switch at the "off" position.

#### **22. Mains Switch(POWER)**

Repetition of pressing this knob ensures alternate switch-on and -off.

#### **23. Mains Cord**

For operation of this receiver the mains plug attached to this cord should be connected to the mains power supply source.

#### **24. Mains Fuse**

In the mains power circuit is inserted a 5A fuse. When the fuse is blown, replace it, ascertain the cause of failure and rendering appropriate remedy. Replacement can be easily done by hand turning the cap to the direction of arrow mark. Be sure that the mains cord is disconnected from the mains power supply point.

### 25. 26. Extra Mains Outlets

Convenient for supply of mains power to other annexed audio equipments such as record player, tape recorder etc. The UNSWITCHED terminals are independent of the mains switch(21) where the mains power is always available, while the SWITCHED one is completed with the mains switch and supply of the mains power depends on the mains switch. The maximum capacity for the UNSWITCHED is 200W, while the SWITCHED is 100W.

### 27. 28. 29. Speaker Terminals(A.B.C. SPEAKERS)

The speaker systems are to be connected to these terminals. Press the cap of the terminal and insert the speakers bare cord to the terminal hole. Then release it. Now firm connection is finished. These terminals are coupled with the speaker selector switch(19), and the selector switch must be set at the very position corresponding to the terminals to which the speaker systems are connected. Red terminal is for ⊕ while black for ⊖. Note that the attached speaker cords should be used for connection of the 1st pair of speakers and be careful so that the connection cords should not come near to the bar antenna. For further details refer to the "Connection of Speakers".

### 30. MW/LW Ferrite Core Antenna

This incorporated antenna functions when the input selector switch is set at the "MW or LW" position. In case strong signals are available it is not always necessary to install the outdoor antenna.

### 31. Tape Connector

This 5-pin connector is of DIN standard. With recording

output(TAPE OUT) and tape monitor(TAPE IN) terminals in it, connection for recording and playback is feasible with a single lead-wire of DIN plug if the tape-recorder has the same connector. For playback through this connector the monitor switch(11) must be at the "deck-2" position. Recording output signals are always available from this connector.

### 32. MW/LW External Antenna Terminal

In case normal reception is possible with the built-in bar antenna, it is not necessary to use this terminal. But when reception of a weak signal is desired, connect a full scale antenna wire to this terminal. When a simple wire antenna is used for this terminal it is not always necessary to have a ground connection which sometimes deteriorates sensitivity. A full scale outdoor antenna is effective to decrease undesired noises.

### 33. FM Antenna Terminal (75Ω)

Use this connector for FM antenna with 75Ω coaxial cable as lead-in wire. A coaxial cable can be easily connected — a core wire to the 75Ω terminal and the sheathing wire to the GND terminal.

### 34. FM Antenna Terminal (300Ω)

Connect to this terminal T type(dipole type) antenna of antenna feeder cable for TV(impedance 300Ω) or FM antenna with TV feeder cable used as a lead-in wire. Please do not use short wire on this terminal as replacement for the antenna, and always connect an exclusive FM antenna.

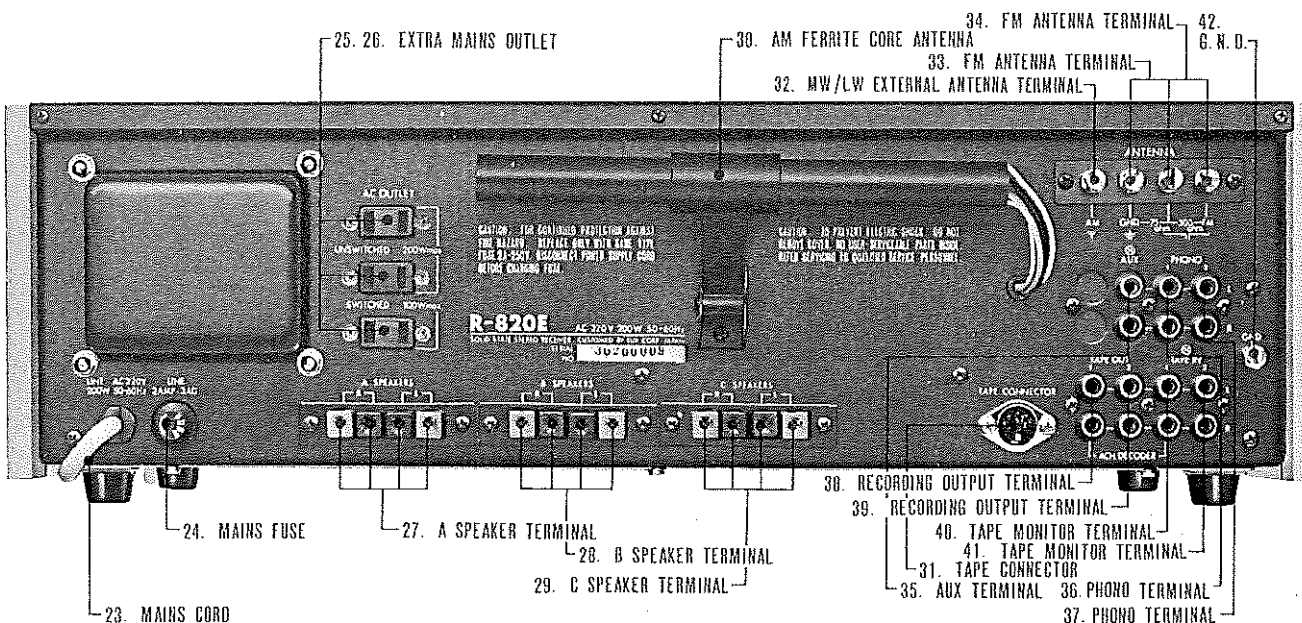

### 35. Aux Terminals (AUX)

This is an auxiliary input terminal for playback of flat frequency response such as SW tuner, line output of tape-recorder, or audio output of TV receiver. Input sensitivity 150mV, and input impedance 60KΩ.

### 36. 37. Phono Terminals(PHONO-1, PHONO-2)

This terminal is for playback of a magnetic pick-up(MM, MI, MC type). Input sensitivity 2.3mV with impedance 50KΩ. Almost all pick-ups can be used except MC type of very low output(0.01 – 0.1mV). For such MC type cartridges of extremely low output level, it is needed to boost the voltage up to the specified level by use of step-up transformers or head-amplifier.

### 38. 39. Recording Output Terminals(TAPE OUT-1, TAPE OUT-2)

Signal for recording is taken out from this terminal. The recording signal is provided to 2 tape-recorders. These 2 terminals are wired in parallel in the inside circuit.

### 40. 41. Tape Monitor Terminals(TAPE IN-1, TAPE IN-2)

Line output of tape-recorder is reproduced from this terminal. For this purpose the monitor switch must be set at "deck-1" or "deck-2". The "deck-1" corresponds to the "TAPE IN-1", while "deck-2" to "TAPE IN-2" and Tape Connector. In case of 3-head tape-recorder so-called tape-monitoring is feasible – simultaneous recording and playback.

#### Note:

This receiver can be used as a front or rear amplifier of quadraphonic reproduction. In case you have 4-channel decoder front or rear 2-channel can be reproduced by this amplifier section. Connect the recording output terminal of this receiver with the input terminal of 4-channel decoder and the tape monitor terminal with the output terminal. Both pairs of terminals, i.e., TAPE OUT-1/TAPE IN-1 and TAPE OUT-2/TAPE IN-2 offer the same facility, but indication of 4-channel availability is made only at the side of TAPE OUT-1/TAPE IN-1 for easy understanding. Needless to say the TAPE OUT-1/TAPE IN-1 side is used for this purpose the monitor switch must be set at the "deck-1" position.

### 42. Ground Terminal(GND)

Connect the earth lead wire of record player(from motor or pick-up arm). This terminal may be used as an earthing terminal of this receiver, which is, however, not always necessary.

## INSTALLATION

While the R-820 Receiver has been designed for maximum ease of installation and operation, we strongly suggest you read this section through before proceeding to connect and operate the unit. Because the R-820 incorporates many technical and operating refinements, it may be a bit different from equipment you have used in the past.

### Placement and Mounting

The R-820 may be placed in virtually any convenient location, keeping in mind the necessity of connecting cables to your speakers and an antenna for FM. Because of its advanced solid-state construction, the unit produces little heat. However, certain minimum ventilation requirements are still necessary to provide optimum operation: When the R-820 is placed on an open shelf in a bookcase or cabinet (mounted in its integral metal case or with the accessory furniture case) about 10cm of free space should be allowed above it.

### Power Requirements and Mains Convenience Outlets

The R-820 Receiver operates on the mains power only, 100-125, and 210-250 volts, 50-60 cycles, consuming 240 watts maximum at full power output. Three convenience outlets are provided on the rear panel to supply the mains power for additional components such as automatic or manual turntables, tape recorders, etc.

The mains cord of a turntable should be connected to one of the unswitched outlets, to permit it to cycle fully before turning off. The mains cords of other components can be connected to the unswitched or switched outlets. When connected to the switched outlet, they will shut off when the receiver is turned off. Not more than 200 watts total should be drawn from the unswitched outlets, nor more than 100 watts from the switched outlet. (If in doubt about the wattage drawn by additional components, check the ratings on their rear panels, or in their manuals. Automatic turntables, for instance, generally draw from 20-50 watts.)

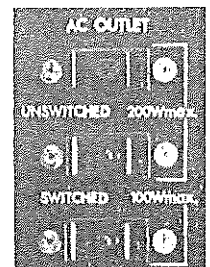

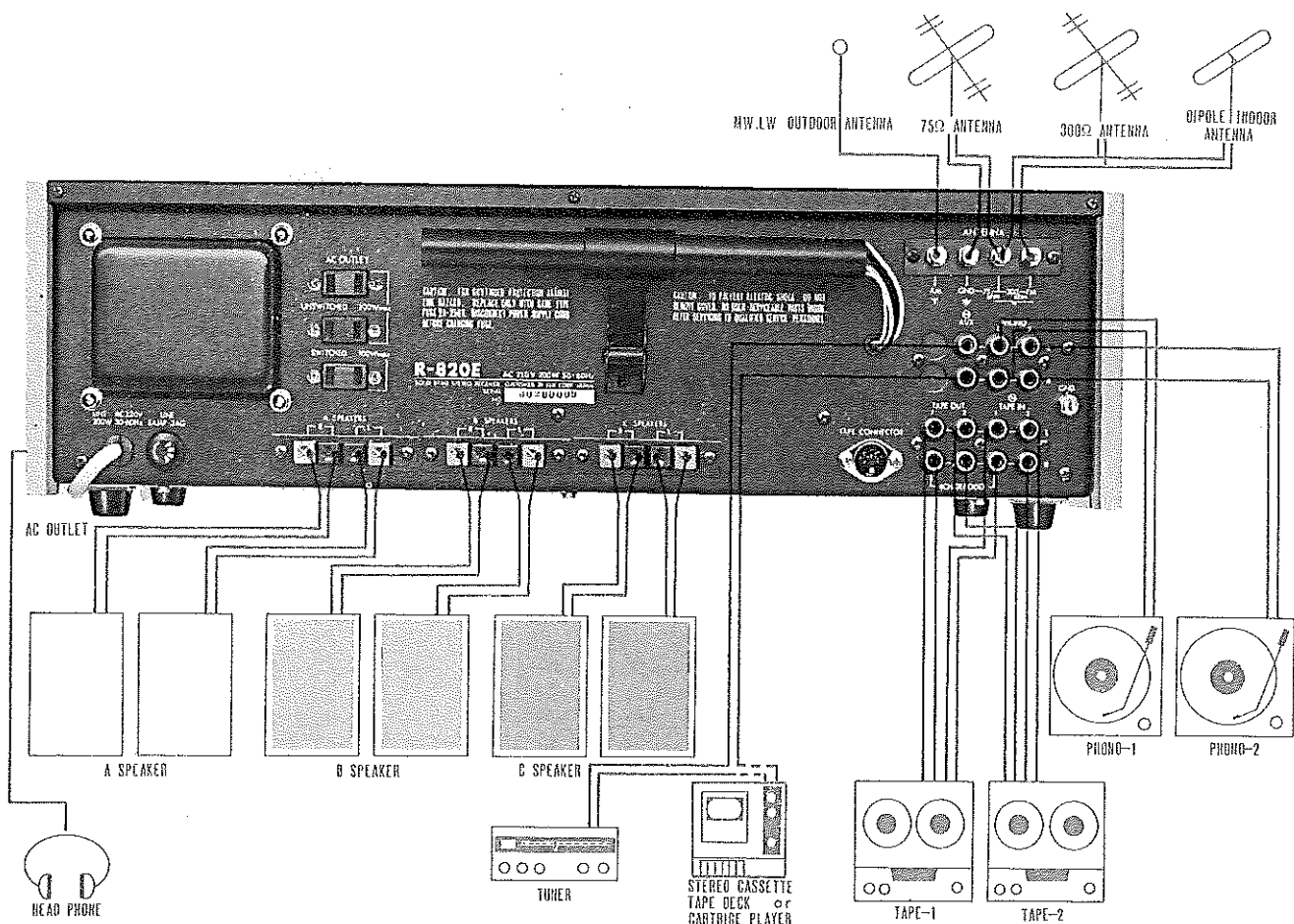

## ANTENNAS

Except in fringe areas no additional MW/LW antenna is required with the R-820. For FM, a folded dipole, available from your dealer, is generally adequate. This section will tell you how to connect them.

### MW/LW Antenna

In all but remote rural locations, the special fold out ferrite loop antenna mounted on the rear of the receiver provides excellent MW/LW reception. For best results, make certain that this antenna is folded out away from the chassis to its maximum extension.

If an external antenna is required, connect a length of wire (any type will do) to the MW/LW ANTENNA terminal on the rear panel.

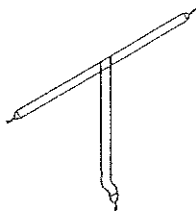
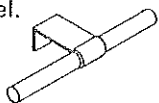

### FM Antenna

#### Folded Dipole

Connect the antenna lugs to the 300-OHM ANTENNA terminals on the rear panel. Rotation of the FM antenna

for best reception will be described under Tuning Control in the OPERATION section of this manual.

### Outside Antenna

If you live in a remote fringe area, or in a metropolitan area with reception problems, it may be necessary to use an outside antenna. If you require a separate FM antenna, purchase a quality FM unit from your dealer. Connect the cable from the antenna to the 300-OHM ANTENNA terminals on the rear of the R-820.

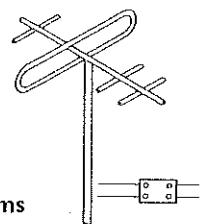
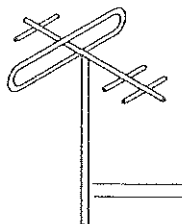

### Master Antenna and Other 75-ohm Systems

Some buildings have master antenna systems that carry FM. Connect to the 75-OHM ANTENNA terminal on the rear of the unit.

**Note:** For clarification, if necessary, see your dealer, who can advise you concerning the best antenna installations.

## LOUDSPEAKERS

The R-820 Receiver is designed to power 3 pairs of speakers, used either separately or 2 together.

Because of its high output power, two pairs of even the lowest-efficiency speaker systems may be used together without fear of placing too heavy a demand upon the unit. Although almost any type of wire may be used to connect speakers to the receiver, it is recommended that you use standard gauge rip cord. For runs over 15m(50ft) heavier gauge rip cord should be used if possible. Whatever thickness of wire you choose, pick the type where you can distinguish one lead from another, either by conductor color, a ridge running along the insulation of one conductor, or by a colored cord under the insulation. This will help you hook up the speakers correctly.

### Please Note

- (1) No more than 1.5cm(1/2") of wire should be bared for hookup, since longer bared lengths may produce a sort circuit.
- (2) Twist all strands of exposed wire tightly. Loose strands may cause shorts.

### Connecting Speakers

Look at your speakers. You will note that one terminal is unmarked. The other will be designated 'COM', 'COMMON', 'GND', 'GROUND', or Black. Connect the 'COM' terminal of each speaker to the appropriate black SPEAKERS terminal(see paragraphs below for which one) on the rear of the receiver by pushing on the terminal and inserting the bare wire in the hole thus exposed. Make sure the wire does not contact the chassis or another terminal, to prevent shorts. Then connect the other speaker terminal to the appropriate red SPEAKERS terminal of the receiver. To connect a single pair of speakers, connect the wires from the left speaker(as viewed from the listening position) to the "L" A SPEAKERS terminals. Similarly, connect the right speaker to the "R" A SPEAKERS terminals of the receiver. See Fig.1 below. The 2nd and 3rd pairs of speakers can be connected similarly to B and C SPEAKERS terminals. See Fig.1 below.

### Speaker Phasing

To enjoy good stereo reproduction, it is necessary that the two stereo speakers in any location work as a team, 'pushing' and 'pulling' the air in unison. Otherwise, low-pitched sounds will sound weaker than they should, and the stereo effect at higher frequencies will become indistinct. To connect your speakers for proper stereo effect

(this is called "phasing"), proceed as follows:

Play an FM program with the Mode Switch in MONO position. If the low bass notes sound normal, the speakers are properly phased. If they sound thin, or weak, the speakers are out of phase. Should this occur, turn off the receiver and carefully reverse the connections at either one of the speakers.

## TURNTABLES/TAPE RECORDERS—DECKS

### Automatic and Manual Turntables

The R-820 has provisions for connection of two turntables. The difference between the two pairs of inputs is that PHONO 2 has a higher sensitivity(2 millivolts) than PHONO 1 (20 millivolts), which affects the output from the receiver. Check the cartridge manual or your dealer, if in doubt about the proper input for the particular cartridge in your turntable. As mentioned under POWER REQUIREMENTS AND MAINS CONVENIENCE OUTLETS, (see page 6 ), the turntable's mains cord can be connected to the convenience outlet on the rear of the R-820.

### Tape Recorders and Decks

Tape recorders can be connected to record and playback through the R-820 by two methods: standard jacks and special DIN type connector on the rear panel.

See Fig.2 for tape connections of all types. For additional information see the manual of your tape machine or consult your dealer.



# BLOCK DIAGRAM

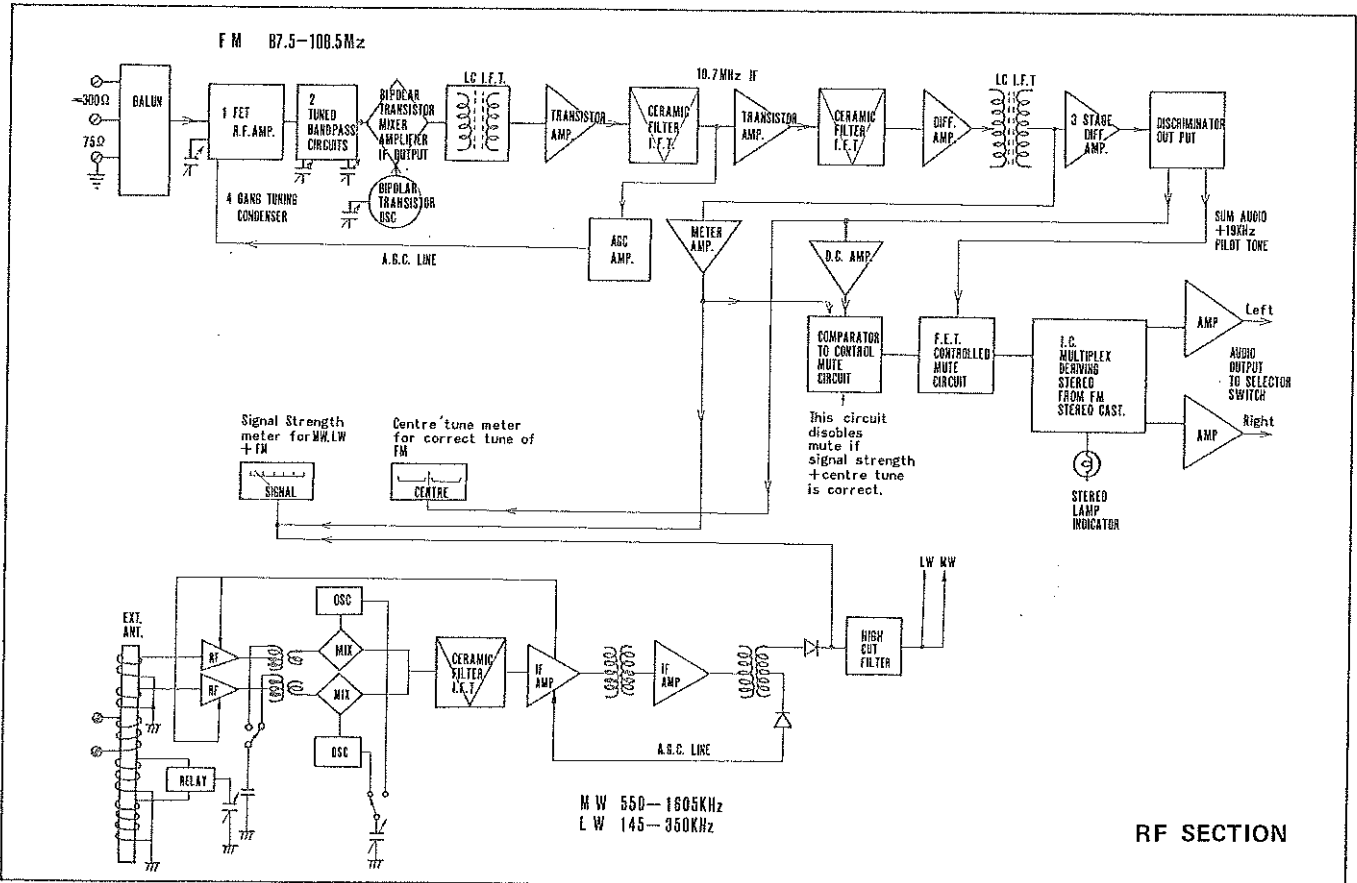
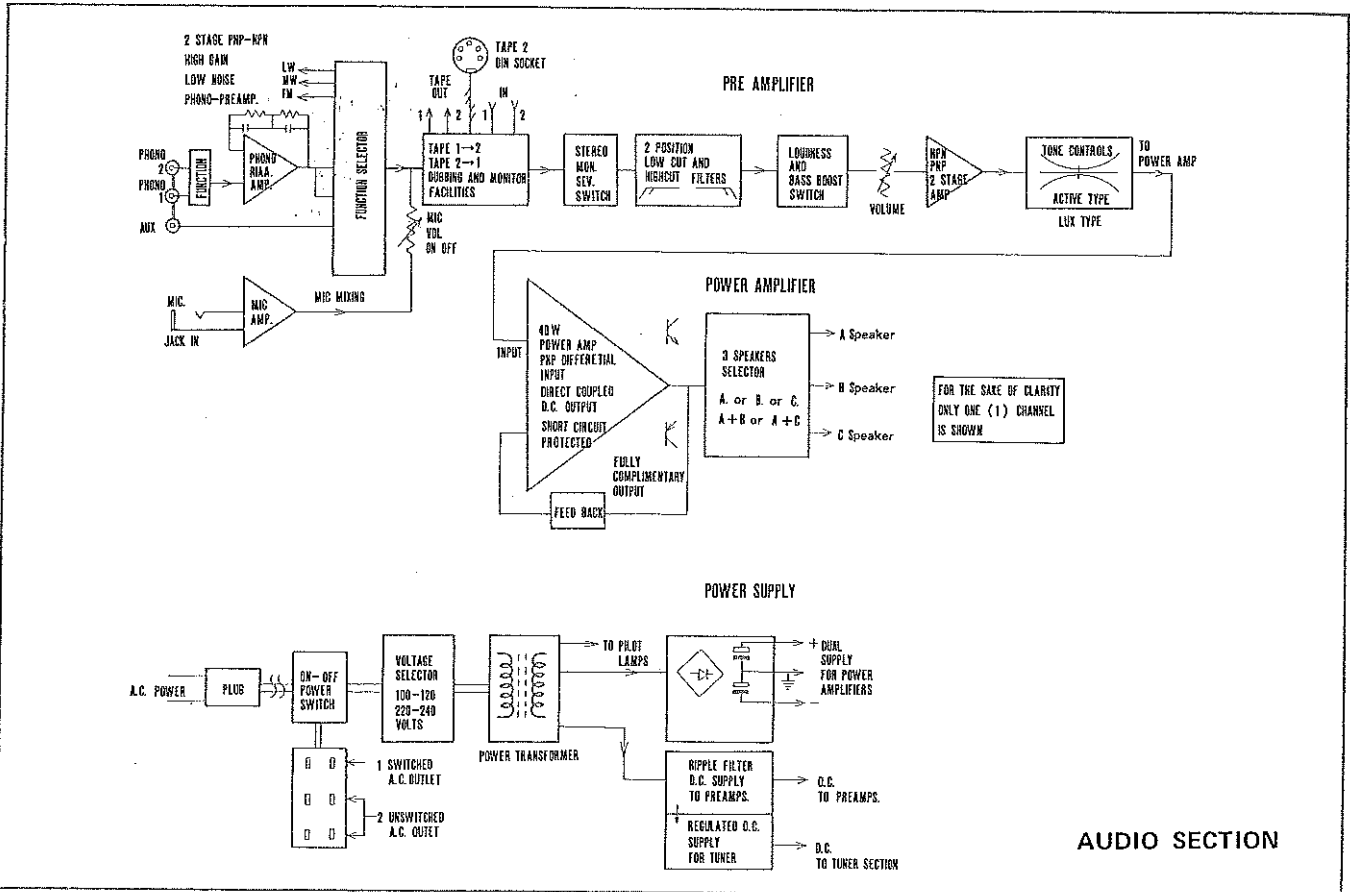

## FOR CORRECT PLAYBACK

### ■ Inputs(Connection of Input Equipments)

Check firm connection to the receiver's input terminals of output terminals of record players, tape-recorders etc. If no playback sound comes from speaker systems, the receiver may be, at first, suspected to be defective, so be sure about firm connection between arm and cartridge and also firm fixture of cartridge to the shell.

### ■ Outputs(Connection of Speaker Systems)

Check firm connection between receiver and speakers. The right-hand speaker viewed from the listener's position must be connected to the "RIGHT" terminals of the amplifier, while the left speaker to the "LEFT" terminals. Be careful about the matching phase of left and right speakers. If mismatched, playback sound does not come from the centre of both speakers even if the mode selector is set at the "MONO" position, and in the case of stereophonic playback, faithful reproduction in low frequency range cannot be expected. Be sure that the speaker selector switch corresponds to the speaker terminals to which the speaker is connected.

### ■ Mains Source(Connection to Mains Source)

Check whether the mains plug of receiver is firmly connected to the mains power source, and whether the pilot lamp lights up when switched on. In case the pilot lamp does not light up even if the electricity is fed to the receiver, check whether the mains fuse is blown. Affirmatively change the fuse ascertaining the real cause of blow and giving necessary treatment. Replacement of fuse must be done after the mains cord is unplugged from the mains power supply point.

### ■ Input Selector Switch

Check correct positioning of the switch corresponding to the input terminals (PHONO, AUX) to which input equipments are connected.

### ■ Tape Reprint Switch

Except for tape dubbing(reprint) this switch should be set at the "source" position.

### ■ Tape Monitor Switch

For normal playback never fail to set this switch at the "source" position. Playback with tape-recorder is feasible with this switch at "deck-1" or "deck-2" corresponding to the tape-monitor terminal to which the tape-recorder is connected. But for reproduction through tape connector

the setting of tape-recorder selector switch should be at the position of "deck-2".

### ■ Volume Control

Full turn of this knob to the counter-clockwise direction yields no sound. Turn to the clockwise direction and enjoy playback at an appropriate volume. Also adjust unbalanced volumes between right and left channels. Usually this knob is set at the same volume level for stereophonic reproduction.

### ■ Antenna

For satisfactory playback of FM and MW/LW connect an appropriate antenna to the antenna terminal.

### ■ Mode Selector

This switch is to select the mode of reproduction. For stereophonic reproduction set at the position of "normal", otherwise stereophonic reproduction cannot be obtained even if input signal is stereophonic.

## OPERATION

### PLAYBACK FROM RECORD DISC

#### ■ Connections

Generally a record player consists of a turn-table ensuring constant rotation of the record disc, a pick-up (cartridge) whose stylus (needle) traces the sound groove of the disc converting the physical signal of the recorded sound into the electric signal, and the arm which holds this cartridge. The player has 2 cords with pin plug at its end for both right and left channels. Connect the pin connectors to the input terminals of this receiver [PHONO-1 (36) or PHONO-2 (37)]. A probable earth lead of player may be connected to the GND terminal (42) of this receiver. A mains cord of the player to drive its motor may be connected to the convenient extra mains outlet (25, 26).

This receiver is provided with 2 input terminals (PHONO-1 and PHONO-2) to be selected by the input selector switch (1) which is useful for comparison test of 2 pick-ups or using 2 record players. For use of 1 player either of 2 input terminals can be selected.

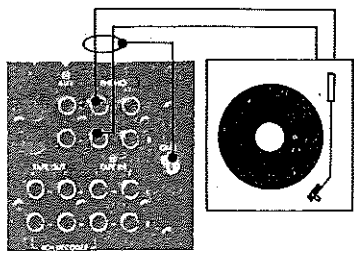

### ■ Signal Paths

Put the disc on the turn-table, switch on the phono motor, and set the stylus on the groove of disc. Then recorded signals begin to be fed to the receiver. First, signals fed to the receiver through PHONO terminals are brought to the equalizer section, where recorded signals are equalized and restored to the original frequency curve. Incidentally this equalizer curve has been standardized to the RIAA curve. The equalized signals are then fed to the input selector switch (function switch). If this switch is not set at the correct position of PHONO, the signals are blocked here and no more advance is possible. Then the signals are divided into 2 channels, one line to the recording output terminal, and the other to the tape monitor switch. Then the tape reprint switch which is effective on both channels. If the monitor switch(11) is set at the "source" position, the signals are sent to the mode selector switch, and volume control, but if at the "deck-1" or "deck-2" position the tape monitor terminals start to function and the signals are stopped at this point. Except when the tape playback is made by tape monitor terminals, the monitor switch must be kept at the "source" position. But when the input signals are fed to PHONO or AUX terminals recording output is always obtainable regardless of the position of the monitor switch. Then the signals are sent to the volume control through the mode selector, filters, and loudness low booster control. If the volume knob is turned to the extreme end of counter-clockwise direction, the signals cannot proceed ahead. It is necessary, to set this control at the optimum volume.

Such controls as low-cut filter, high-cut filter, loudness, low booster, and tone controls are for flexible and diversified adjustment of playback sound and do not block the signals completely.

Then the signals reach the speaker switches amplified by the main amplifier. Sound playback from speaker systems is thus realized if the speaker switch corresponding to the speaker terminals to which the speakers are connected is set at the correct position.

The above is the feeding path of PHONO signals starting from input terminals to the speaker systems. Difficult as it may sound you can easily understand it from the

attached block diagram. For your pleasant command of this receiver we recommend you to bear the block diagram in your mind.

### ■ Playback Performance

Now put a disc on the turn-table for playback performance. As the volume control is turned clockwise from the cut position, playback sound comes out from speakers. As explained in the paragraph of Signal Paths the sound playback is possible regardless of the position of Mode Selector etc. as far as these essential controls are set at the correct position such as Input Selector Switch(1), Tape Reprinting Switch(10), Monitor Switch(11), Speaker Selector Switch(20) and Volume Control(19). Now all preparations have been completed. Check if the volume levels on both right and left speakers are identical. If deviated adjust it by the Volume Control. For stereophonic playback see to it that the Mode Selector Switch is kept at the "normal" position, otherwise stereophonic playback is not feasible.

### PLAYBACK OF MW/LW/FM BROADCASTING PROGRAM

Selection of the input selector(1) at the MW/LW or FM position ensures playback of MW/LW or FM broadcasting programme. If you want you can connect other tuner (FM, or SW etc.) to the AUX terminals of this receiver. In this case the selector must be set at the corresponding position. As shown in the block diagram the input signals from the tuner section or Aux terminals are directly fed to the Input Selector Switch. Afterwards the signals trace the same blocks as explained in the paragraph of Playback from Record Disc and are reproduced from the speaker systems. Both for FM stereophonic and monaural broadcasting the Mode Selector Switch can be set at the position of "normal", for such accommodation to the input source can be made in the tuner section. In case weak FM stereo is received and you feel it noisy, set the Mode Selector Switch(14) at the "mix" position for better reproduction. In case of SW programme from other tuner there is possible trouble of modulation hum, which can be eliminated by varying the distance and angle of these components.

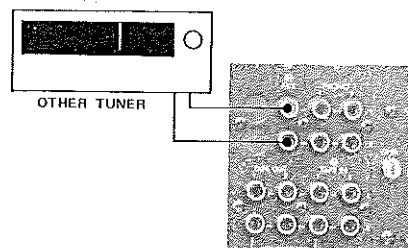

## OTHER PLAYBACK

The signals of flat frequency response from such sources as TV receivers do not need an equalizer stage, and for playback of such audio equipments, this AUX terminal can be used. Connection and operation is same with that of MW/LW/FW broadcasting programme.

## PLAYBACK FROM TAPE

### ■ Playback from Tape Monitor Terminals

Almost all of tape-recorder, and tape-decks currently marketed integrate audio preamplifiers in their circuit. Also there is a tape-player exclusively for playback. Connect the output terminal (LINE OUT) to the Tape Monitor Terminals (40) (41). Then set the Monitor Switch (11) at the "corresponding" position and the playback from tape is realized. If 2 tape recorders are connected to the Terminals (40) and (41), selection between 2 tape-recorders is possible by the Monitor Switch(11). This amplifier section can be divided into 2 sections — one before the Recording Output Terminals (REC. OUT) and the other after the Tape Monitor Switch, and 3-head tape-recorder makes it feasible to make recording with the former section and simultaneously to make playback with the latter section. Note that normal function cannot be expected if 2 sets of tape-recorder for playback are connected to the terminals of TAPE-2 and Tape Connector (31) at the same time, since these 2 are coupled in the inside circuit and effect each other. Therefore if Tape-Monitor Terminals and Tape Connector are used the tape-recorders should be connected to the terminals of TAPE-1 and the Tape Connector.

### ■ Playback from AUX Terminals

Playback of tape is possible if the line output of tape recorder or tape-deck is connected to the AUX terminals of this receiver by use of pin-jack lead and the Input Selector Switch is set at the corresponding position to the AUX Terminals. All operations in this case are same with those for the Playback of Tuner. Note that when tape playback is made through AUX terminals the line input or AUX input terminals should be kept free. If connected to the Recording Output Terminals (TAPE OUT) of the receiver there will be possible oscillation by feed-back of signals.

### ■ Playback from Tape Connector

This connector is of DIN norm, and very convenient for simple connection by a single patch cord between the tape-recorder and recording/playback connectors of this

receiver. A DIN cord should be connected between DIN connector of the tape-recorder and Tape Connector of this receiver. Playback from Tape Connector is possible if the Monitor Switch is set at the "deck-2" position.

## RECORDING ON TAPE

In case of playback of various programme sources through input terminals of this amplifier, the same signals to these reproduced in speakers are available at the Recording Output Terminals (38, 39) and Tape Connector (31) if the Tape Reprinting Switch is set at the "source" position. By connection of these terminals to the input terminals (AUX or LINE-IN) of the tape recorder you can enjoy simultaneous recording and playback. These recording signals are taken out before the Tape Monitor Switch and there is no influence of such controls as Volume Controls, Tone Controls and Filters etc.

## TAPE DUBBING

So called tape dubbing — tape-to-tape reprinting is possible with the Tape Reprinting Switch(10). Tape reprinting is possible when the switch is set at the "up" (1 to 2) or "down" (2 to 1) position. At the "(1 to 2)" position connect the LINE-OUT terminals of the tape-recorder with recorded tape to the TAPE IN-1 (40) while the LINE-IN (Aux) terminals of the second tape-recorder to the "TAPE OUT-2" (39), the tape reprint is possible from the 1st to 2nd tape-recorder: vice versa at the "2 to 1" position. Similarly tape reprinting is possible between the TAPE-1 and the tape connector. In the dubbing process if the LINE-IN terminals of the 1st tape-recorder is connected to the "TAPE OUT-1" (38) and the LINE-OUT of the 2nd tape-recorder to the "TAPE IN-2" (41) simple operation of the Monitor Switch(11) between "deck-1" and "deck-2" allows comparison between the original sound and newly recorded one. Remember that for reproduction of other programme sources than tape this switch as well as the Tape Monitor Switch(11) must be set at the centre "source" position.

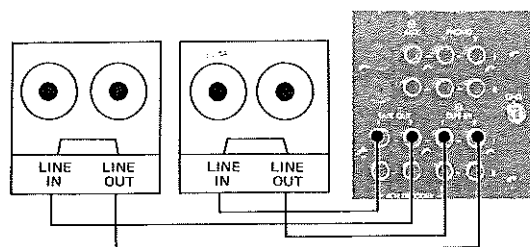

If there are 2 tape-recorders reprinting of tape is feasible also by other method; Connect the tape-recorder of better recording performance to the Recording Output Terminals and other one to the AUX terminals exclusively for playback setting the Input Selector Switch to the relevant position.

### SIMULTANEOUS PLAYBACK MONITORING

3-head tape-recorder ensures Simultaneous Playback Monitoring enabling to ascertain perfect recording. In case of 3-head tape-recorder heads and amplifiers for recording and playback exist independently in the circuit, which ensures simultaneous recording on tape and playback of the sound recorded on the tape.

In this case recording on tape and playback of the recorded sound is practised at the same time, and connection must be made for both functions. Need to connect the Recording Output Terminals (38) or (39) to the Line Input Terminals (Aux. Input) of tape-recorder, and the Tape Monitor Terminals (40) or (41) to the Output Terminals (LINE OUT) of the tape-recorder and to set the Tape Reprinting Switch at the "Source" position.

The Monitor Switch(11) is set at the position corresponding to the terminals to which the tape-recorder is connected, and repetition of switching between "source" and "deck-1" or "deck-2" makes it feasible to compare the original sound with recorded one. Thus possible recording error can be prevented in case of 3-head tape-recorder. Incidentally note that reproduction of recorded sound becomes a little bit delayed as compared with that of original sound since there is a gap between recording head and playback head. Simultaneous Playback Monitoring can be made through the Tape Connector(31) as well. A single DIN patch cord ensures connection for recording and playback, and simple operation of switching between "source" and "deck-2" of the Monitor Switch will do.

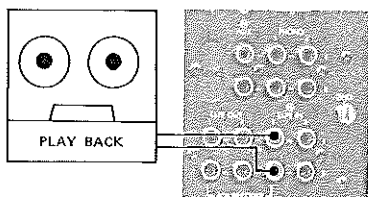

### SIMULTANEOUS RECORDING

This amplifier is provided with 2 sets of Recording Output Terminals (TAPE OUT) enabling to record simultaneously on 2 tape-recorders. If desired, combination recording on open-reel recorders and/or cassette recorders can be enjoyed. Moreover if the Tape Connector is used recording

on 3 tape-recorders is possible. Remember that the Tape Reprinting Switch(10) must be set at the "source" position. This facility is useful for safer printing or effective recording etc. As the impedance at the Recording Output Terminals is kept sufficiently low (about 100Ω), mutual interference will be almost nil between the recorders under simultaneous operation.

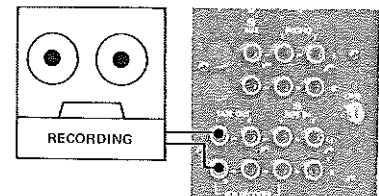

### About DIN Tape Connector

The Tape Connector of this amplifier is provided at the rear panel for convenient connection. This is of DIN norm. As explained in the paragraph of Playback from Tape and Recording on Tape, if tape-recorder is equipped with DIN connector, connection by a DIN patch cord suffices for recording and playback. See to it that this connection is practised only by DIN cord since the impedance at Recording Output Terminals is kept relatively high at  $80K\Omega \pm 20K\Omega$ .

### OPERATION OF TONE CONTROLS

#### Selection of Mode (Conversion of Playback Mode)

This amplifier is for stereophonic reproduction and integrates independent amplifiers for 2 channels (right and left). Without the Mode Selector the signals fed to the right channel terminal are reproduced at the right channel speaker. The Mode Selector is placed between these 2 amplifiers to change the mode of reproduction.

knob position	connection input    output	performance	use
NORMAL	R → R L → L	normal stereo playback	for normal stereo playback
REVERSE	R → L L → R	reversed stereo playback	when program source is reversely connected
MIX	R → R L → L	right and left input signals are integrated	for monaural playback of stereo program

### Control of Volume

Sound volume can be properly adjusted by volume control. In the attenuation characteristics of turning angle is proportionate to attenuation degree of dB, and the dB value and the volume audible to human ears are in the proportionate relation. That is to say, the rotation of knob is in proportion to the sound volume felt by human ears.

The increasing degree of volume is felt quite natural as the knob is turned on to the clockwise direction.

#### **Control of Volume Balance**

In case of deviation between the volume levels of right and left channels, adjust unbalanced volume level by the Volume Control(8). The volume balance of both channels can be adjusted so that monaural disc sound reproduced by the stereo cartridge comes from the centre of the right and left channels. Usually the volume level of both channels is adjusted identical at the straight engraved line on the knob. If a programme source has deviation of the volume level between 2 channels, establish correct balance with this balancer.

#### **Tone Controls**

The ultimate purpose of the audio system is to make the high fidelity reproduction of programme sources. The reproduction conditions and circumstances do not always match with recording conditions, and it is impossible to reproduce the same sound with the original one. Also there is no objective standard to judge good sound from inferior one. The only possible solution is for every listener to create his favorite sound according to his own taste. It is therefore very important that the audio system offers such facility to permit flexible controls for creation of the best sound. This receiver is equipped with various tone controls for subtle and minute control of the reproduced sound such as Bass Level Control(12, 13) and Treble Level Control(2, 3).

Bass Level Control is a tone control on frequency response of low frequency range. It is designed so that response is flat at the electric centre point, and a clockwise turn of the knob intensifies low frequency range while counter-clockwise turn yields attenuation. For easy adjustment this control is equipped with 11 points of click stopper.

#### **Operation of Low Cut Filter**

When this filter(15) is switched on the amount of low frequencies you hear is reduced sharply at the attenuation rate of 6dB/oct below 70Hz or 20Hz. Useful for removal of low frequency noise such as rumbling of phono motor. Also this can be used as an auxiliary control for Bass Level Control.

#### **Operation of High Cut Filter**

When this filter (16) is switched on the amount of high frequency range over 6KHz or 12KHz is cut off at the attenuation rate of 6dB/oct. Useful for removal of scratch

noise, hissing noise of tape etc. Also this can be used as an auxiliary control for Treble Level Control.

#### **Operation of Low Booster and Loudness**

When this switch (17) is set on at the "up" position, low frequency range is intensified. This circuit effective only on the extreme low frequency range allows flexible and versatile tone adjustment. For instance probable rise-up in small room of approx. 10cm<sup>2</sup> in the neighbourhood of 150 – 200Hz can be subdued with switching on of this control by lowering the bass level by the Bass Level Control. This process can suppress such unnecessary rise-up without spoiling the response at extreme low frequency range. Moreover when human voice sounds unnaturally stout, it can be adjusted as clear and natural one if this booster is switched on cutting low frequency range to small extent by Bass Level Control.

While the "down" position stands for Loudness. Because loudspeakers and human ears respond less to extreme low and high (bass and treble) frequencies as volume levels are reduced, the Loudness position is provided to boost these frequencies and thereby to offer tonal compensation. Whether or not you use this position depends on the levels at which you generally listen, the kind of speakers you have, room acoustics and a number of other variables. Experimentation is the best guide to using the Loudness position.

If the switch is set at the centre position(normal) a flat frequency response is obtained.

**POWER T.H.D. (BOTH CH. DRIVEN)**

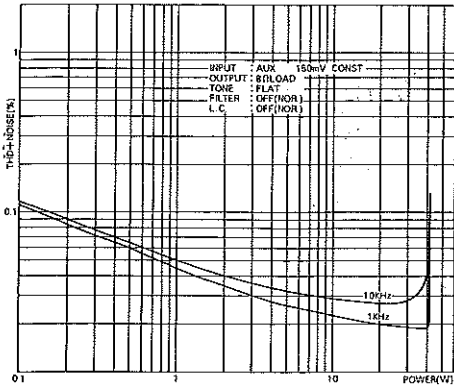

**AUDIO SECTION**

**FREQUENCY T.H.D. (BOTH CH. DRIVEN)**

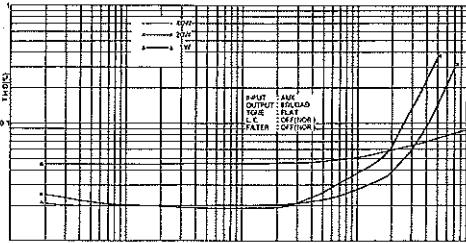

**TONE CONTROL**

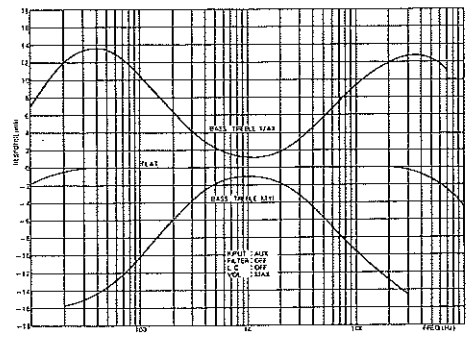

**POWER IMD**

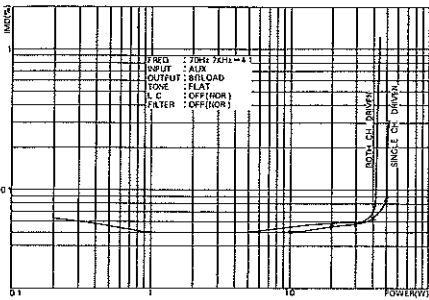

**FILTER**

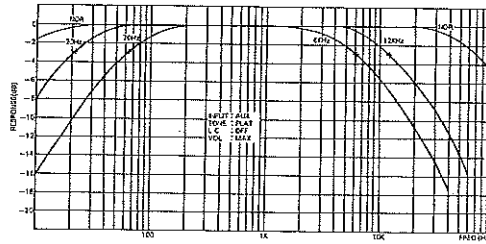

**LOUDNESS/LOW BOOST**

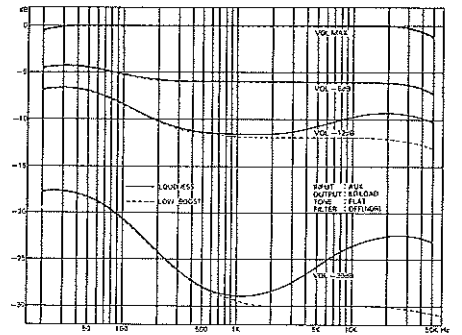

**SELECTIVITY**

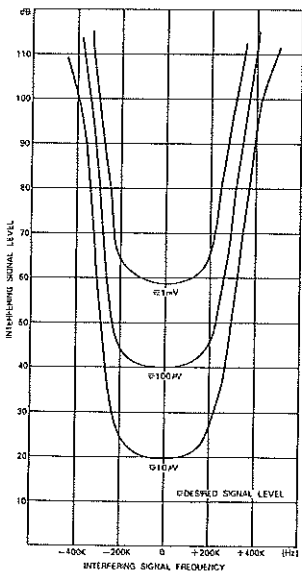

**RF SECTION**

**FM CHARACTERISTIC**

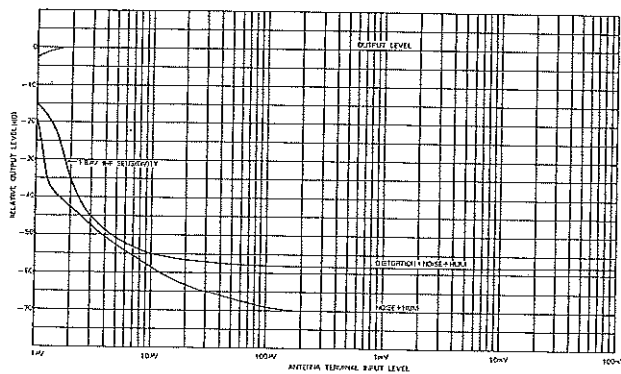

**DISTORTION**

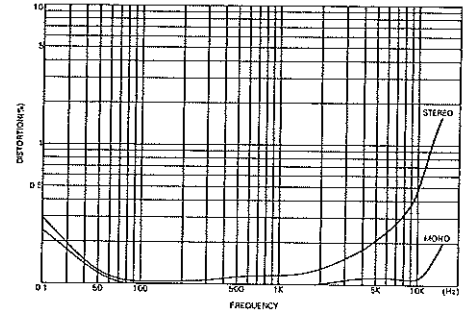

**STEREO SEPARATION**

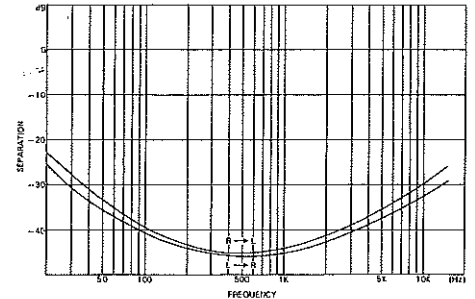

## SPECIFICATIONS

### ■ AUDIO SECTION

**CIRCUIT:** Fully complimentary direct coupled D.C. output amp utilising dual rail power supply

**RMS POWER:** 40/40Watts (8ohms both channel driven)  
45/45Watts (4ohms both channel driven)

**T.H.D.:** <0.05% (8ohms, 40Watts)  
<0.05% (4ohms, 45Watts)

**FREQUENCY RESPONSE:** 15Hz -- 35KHz (-1dB)  
5Hz -- 75KHz (-3dB)

**POWER BANDWIDTH:** 5Hz -- 40KHz (0.1%, -3dB)

**INPUT SENSITIVITY:** PHONO 1, PHONO 2 2.3mV  
(at 40Watts, 8ohms)  
AUX 150mV  
(at 40Watts, 8ohms)  
TAPE MONITOR 1, 2 150mV  
(at 40Watts, 8ohms)  
MIC 2mV  
(at 40Watts, 8ohms)

**REC OUT:** RCA type pin-plug 150mV, 100ohms  
DIN pin-plug 30mV, 90Kohms  
R.I.A.A.

**EQUALIZER CURVE:** R.I.A.A.

**PERMISSIBLE PHONO INPUT VOLTAGE:** 100mV at 1KHz

**TONE CONTROL:** Treble & Bass Lux type NF tone control turnover frequency  
Treble: 3KHz ±9.5dB  
Bass: 300Hz ±10.5dB

**FILTER:** LOW CUT 70Hz, 20Hz 6dB/oct.  
HIGH CUT 6KHz, 12KHz 6dB/oct.

**LOUDNESS CONTROL:** YES

**SN RATIO:** Phono 1, Phono 2 >66dB MIC 60dB  
Aux >85dB  
Monitor >85dB

**RESIDUAL NOISE:** <0.9mV; 86dB

**ACCESSORIES:** Head-phone Jack, Mode Selector (stereo-rev-mix)  
AC outlet, Voltage selector (100, 120, 220, 240V)  
Speaker selector (A, B, C, A+B, A+C)  
Dual monitor circuit (useful for tape to tape dubbing)  
Protection circuit for amp.  
Mic Mixing, etc.

### ■ FM SECTION (87.5 - 108MHz)

**IHF SENSITIVITY:** 1.8μV

**SENSITIVITY FOR 50dB S/N:** 3.6μV

**ULTIMATE S/N:** 70dB

**THD, Mono:** 0.3% (at 400Hz)

**Stereo:** 0.4% (at 400Hz)

**ALTERNATE CHANNEL SELECTIVITY:** 70dB

**IF REJECTION:** 90dB

**IMAGE REJECTION:** 90dB

**SPURIOUS RESPONSE REJECTION:** 90dB

**AM SUPPRESSION:** 55dB

**CAPTURE RATIO:** 1.3dB

**STEREO SEPARATION:** (400Hz) 40dB

**FROM 100Hz TO 10KHz:** 30dB

**MUTING THRESHOLD:** 7μV

**STEREO THRESHOLD:** 7μV

**FREQUENCY RESPONSE (MONO AND STEREO):** 30 to 15,000Hz <sup>+0.2</sup><sub>-1.5</sub>dB

### ■ AM SECTION (Medium wave 525 - 1605KHz) (Long wave 145 - 350KHz)

**MW IHF SENSITIVITY:** 160μV/M

**S/N RATIO:** 48dB

**IF REJECTION:** 85dB

**IMAGE REJECTION:** 72dB

**THD:** 0.6%

**LW IHF SENSITIVITY:** 350μV/M

**SN RATIO:** 47dB

**IF REJECTION:** 70dB

**IMAGE REJECTION:** 70dB

**THD:** 1.2%

### ■ GENERAL SPECIFICATIONS

**POWER REQUIREMENTS:** 100/120/220/240V 50-60Hz AC

**POWER CONSUMPTION:** 35-160 V.A.

**DIMENSIONS:** (W) 480mm (18-1/8") x (D) 360mm  
(14-3/16") x (H) 130mm (5-1/8")

 **LUX CORPORATION, JAPAN**

**HEAD OFFICE & FACTORY** 1-8-31 NAGAHASHI, NISHINARI-KU, OSAKA  
PHONES: 632 0031 CABLE: LUXELECT OSAKA  
TELEX: J63694

**INTERNATIONAL DIVISION** NO. 13, 2-23, YUSHIMA, BUNKYO-KU, TOKYO  
PHONES: 833 7691 CABLE: TOKLUXMAN TOKYO